



FORNITURI & COMPONENTI s.p.a.

SPT: 50061

I.M.: B

Dis.: 33
Disegn.: POZZOLI

Date: 17.01.06

Visto: ..
Check: ..

Date: 17.01.06

Denominazione: CASSETTO PRIME H=122 ESTRAZIONE TOTALE
Part Name: PRIME DRAWER H=122 FULL EXTENSION

Pag: 1/2

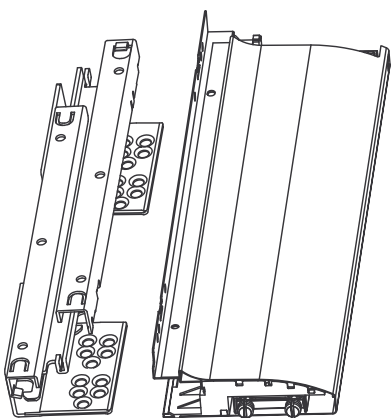

VERS. PRESSIONE PRESS. VERSION



NO-TOOL BRACKET

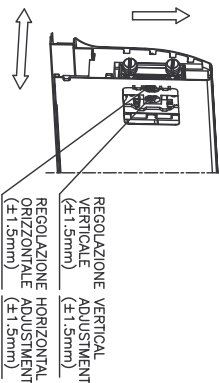
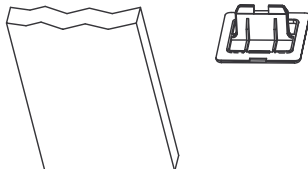

REGOLAZIONE VERTICALE ADJUSTMENT (±1.5mm)
REGOLAZIONE ORIZZONTALE ADJUSTMENT (±1.5mm)

POSTERIORE LAMIERA METAL BACK PANEL



POSTERIORE LEGNO WOODEN BACK PANEL



FORATURA FRONTALE E INCOGNTRI

FRONT DRILLING AND DIMENSIONS

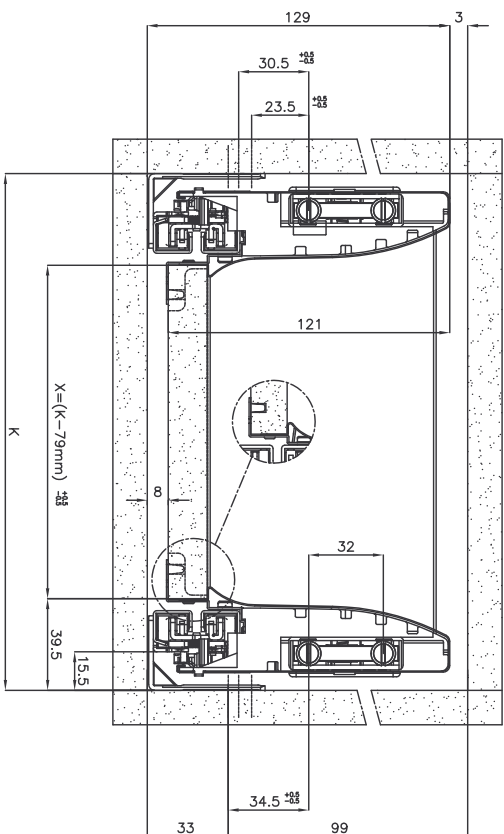

FORNITURI & COMPONENTI s.p.a.

SPT: 50061

I.M.: B

Dis.: 33
Disegn.: POZZOLI

Date: 17.01.06

Visto: ..
Check: ..

Date: 17.01.06

Denominazione: CASSETTO PRIME H=122 ESTRAZIONE TOTALE
Part Name: PRIME DRAWER H=122 FULL EXTENSION

Pag: 2/2

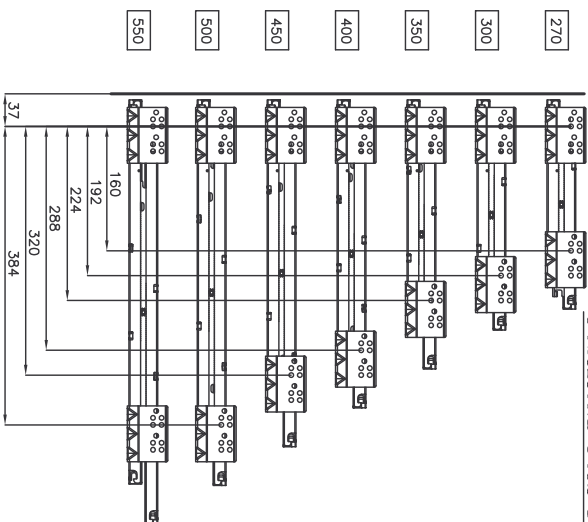

POSIZIONE FORI DI FISSAGGIO

DRILLING PATTERN

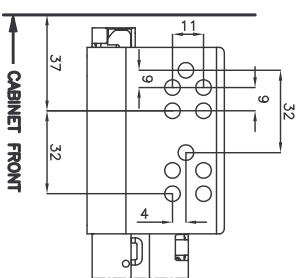

PANNELLO POSTERIORE LAMIERA H=122

METAL BACK PANEL H=122

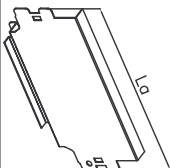

SPALLI PANEL

19mm	P24	S792	S1342	S1392	S1442	S1492	S1542	S1592	S1642	S1692	S1742	S1792	S1842	S1892	S1942	S1992	S2042
18mm	P24	S794	S1344	S1394	S1444	S1494	S1544	S1594	S1644	S1694	S1744	S1794	S1844	S1894	S1944	S1994	S2044
16mm	P28	S798	S1348	S1398	S1448	S1498	S1548	S1598	S1648	S1698	S1748	S1798	S1848	S1898	S1948	S1998	S2048
15mm	P30	S800	S1350	S1400	S1450	S1500	S1550	S1600	S1650	S1700	S1750	S1800	S1850	S1900	S1950	S2000	S2050
CABINET	300	350	400	450	500	600	700	800	900	1000	1200						

LUNGEREZZA PIANETTO

LENGHT OF DRAWER BOTTOM PANEL

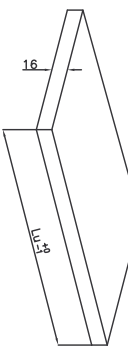

PRESSATA/GROOVE

CASSETTO/DRAWER	Lu
270	268mm
300	295mm
350	345mm
400	395mm
450	445mm
500	495mm
550	545mm

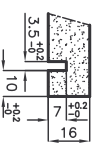

PANNELLO POSTERIORE LEGNO

WOODEN BACK PANEL

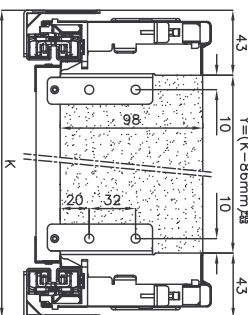

PERDITE D'ESTRAZIONE (AV)

SIZES AND EXTENSION LOSSES (AV)



CASSETTO/DRAWER	AV	AV	P
270	-0mm	275	
300	-0mm	302	
350	-0mm	352	
400	-0mm	402	
450	-0mm	452	
500	-0mm	502	
550	-0mm	552	